



Professional

Index of contents

Structure of standardization organization	3
General standards	4
Modular connectors vs. RJ-trade name	5
Configuration RJ-45 (IEC 60603-7-5)	6 - 7
Translation American Wire Gauge to metric system	8
Bending radius for installation cable	9
Categories and NEW terms EN 50173-1, ISO/IEC 11801	10 - 11
Category 6 _A is not Category 6A	12 - 13
De-embedded – Re-embedded	14 - 15
Coding for optical fiber cable acc. VDE DIN 0888	16 - 17
Optical fiber color code	18
Performance for Ethernet	19
New classification for optical fiber	20 - 21
Optical transfer windows	22 - 23
Connector	24 - 25
IP enclosure type	26 - 27

Structure of standardization organization

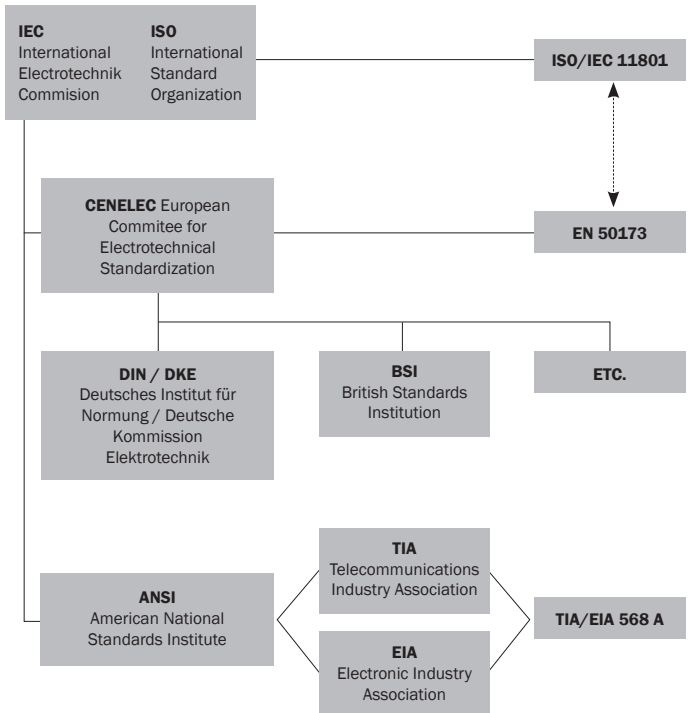

General standards for balanced cable and structured wiring systems

Norm	Content
ISO/IEC 11801:2002	Generic cabling Systems
EN 50173-1:2003	Information technology – Generic cabling for customer premises
EN 50174-2	Information technology – Cabling installation – Planning and practices inside buildings
IEC 61156-1 ... 7	Multi-core metal data and control cables for analog and digital transmission
EN 55022	EMV standard Office Environment
IEC 60603-7-3	EMV standard Office Environment up to 100 MHz (Category 5)
IEC 60603-7-5	Connectors for electronic equipment for data transmissions with frequencies up to 250 MHz (Category 6)
IEC 60603-7-7	Connectors for electronic equipment for data transmissions with frequencies up to 600 MHz (Category 7)
IEC 61076-3-104	Connectors for electronic equipment for data transmissions with frequencies up to 1000 MHz (Category 7a)
ANSI/TIA/EIA 568-B.2	Commercial Building Telecommunications Cabling Standard

Version of modular connectors vs. RJ-trade name

Contacts	Type
4P 4C	RJ 10 (RJ 14)
6P 4C	RJ 11
6P 6C	RJ 12
8P 8C	RJ 45

Category	RJ-45 connector	Remark	Frequency
5	IEC 60603-7-2/-3	UTP/STP	1-100 MHz
6	IEC 60603-7-4/-5	UTP/STP	1-250 MHz
6 _A	IEC 60603-7-4/-5	UTP/STP	1-500 MHz
7	IEC 60603-7-7	GG45-Connector	1-600 MHz
7 _A	IEC 61076-3-104	TERA-Connector	1-1000 MHz

Contact Configuration and color code for RJ-45 connectors

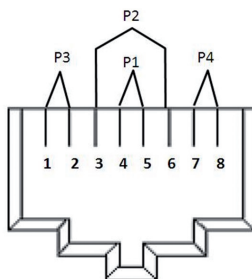
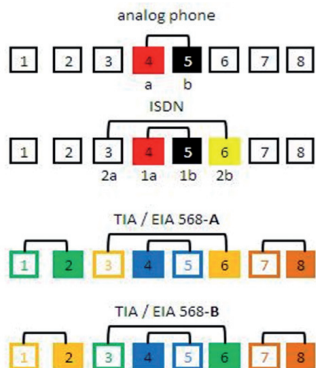
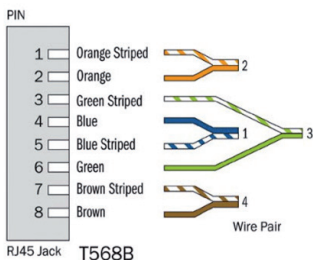
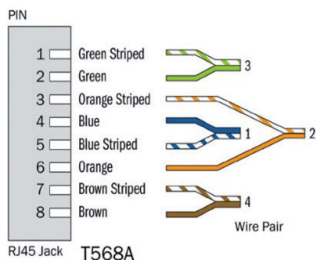

Configuration RJ-45 according (IEC 60603-7-5)

Configuration RJ-45 according (IEC 60603-7-5)								
Application	1	2	3	4	5	6	7	8
10BaseT, 100 BaseTX	Tx+	Tx-	Rx+			Rx-		
Gigabit-Ethernet (100BaseT), 100BaseT4	D1+	D1-	D2+	D3+	D3-	D2-	D4+	D4-
ATM/TP-PMD	1a	1b						
Token Ring			2a	1a	1b	2b		
U_{PO} , U_{200} , U_{2B1Q} , U^*			2a ¹	1a	1b	2b ¹		
Analog phone, (international)		a2	W ²	a	b	E ²	b2	
ISDN S ₀			2a	1a	1b	2b		
ISDN S _{2M} (E1) at Network termination	TX (NT)	TX (NT)		RX (NT)	RX (NT)			
ISDN S _{2M} (E1) at Terminal Equipment	RX (TE)	RX (TE)		TX (TE)	TX (TE)			

Translation American Wire Gauge to metric system

AWG	Wire diameter mm (solid)	Wire cross section mm ² (braid)
18	1,013	0,807
19	0,866	0,641
20	0,772	0,509
21	0,688	0,404
22	0,610	0,318
23	0,546	0,254
24	0,485	0,201
25	0,432	0,159
26	0,384	0,126
27	0,358	0,1
28	0,318	0,079

Bending radius for installation cable

Reference data bending radius for installation cable		
	Flexible multicore cable	
diameter	Free movable	Installed
Ø 8 ... 12mm	4 x Ø	3 x Ø
Ø 12 ... 20mm	5 x Ø	4 x Ø
	Copper cable acc. EN 50173	
During installation	5 x Ø	
After installation	Single 4 x Ø	
	Optical fiber cable	
Single core	min. 30mm	
Multi core	15 ... 20 x Ø	

Categories and classes for copper components according EN 50173-1, ISO/IEC 11801 2nd Edition

Max. Bandwidth in MHz	Category	Class	Application
0,1	1	A	PBX, V11
1	2	B	1 Mbit Ethernet
16	3	C	10 Mbit Ethernet
100	5	D	10/100 Mbit Ethernet
250	6	E	> 1 Gbit Ethernet
500	6 _A	E _A	10 Gbit Ethernet
600	7	F	> 10 Gbit Ethernet
1000	7 _A	F _A	Multimedia

NEW Link definition according, ISO/IEC 11801 2nd Edition

**Campus –
distribution rack**

**Building –
distribution rack**
(e.g. DN-19 42U-8/8)

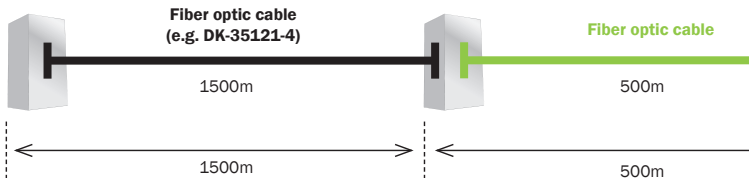

NEW terms for data-cable according EN 50173-1, ISO/IEC 11801 2nd Edition

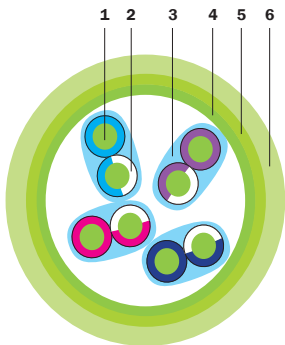

		SF/ UTP	S/FTP (PIMF)	U/ UTP	F/ UTP
1	copper conductor	*	*	*	*
2	isolation conductor	*	*	*	*
3	pair screen		*		
4	overall screen	*	*		*
5	copper braid	*	*		
6	cable jacket	*	*	*	*

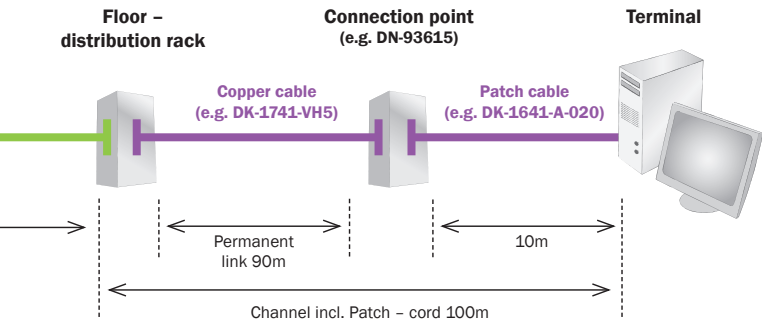

Category 6_A is not Category 6A

Channel

- Class E_A of ISO/IEC 11801 and EN 50173 Amendment 1
- Category 6A of IEA/TIA 568B.2-10

Permanent Link

- Class E_A of ISO/IEC 11801 and EN 50173 Amendment 2
- Category 6A of IEA/TIA 568B.2-10

Connector & Cable

- Category 6_A of ISO/IEC 11801 and EN 50173 Amendment 2
- Category 6A of IEA/TIA 568B.2-10

Frequenz	NEXT Channel	
	ISO/IEC 11801 AM1	EIA/TIA 568B.2-10
	Class E_A	Category 6A
1	65	65
100	39,9	39,9
250	33,1	33,1
500	27,9	26,1

Category 6_A is not Category 6A

Frequenz	NEXT Permanent Link	
	ISO/IEC 11801 AM2	EIA/TIA 568B.2-10
	Class E_A	Category 6A
1	65	65
100	41,8	41,8
250	35,3	35,3
500	29,2	26,7

Frequenz	NEXT Connector	
	ISO/IEC 11801 AM2	EIA/TIA 568B.2-10
	Class E_A	Category 6A
1	75	75
100	54	54
250	46	46
500	37	34

De-embedded – Re-embedded

	Category	Test procedure	Quantity of test plug
100 MHz	Cat 5	Single test – Terminated open circuit	1
250 MHz	Cat 6	Multiplex test cycle – De-embedded	12
500 MHz	Cat 6 _A	Direct probe fixture – Re-embedded	1*
1000 MHz	Cat 7 _A	Direct probe fixture – Re-embedded	1**

(*) detection of limits (e.g. NEXT) after subtraction of the 12 measured parameters

(**) detection of limits (e.g. NEXT) with a calculated simulation by 14 virtual test plugs

De-embedded – Re-embedded

Defined test procedures acc.	
Re-embedded	De-embedded
IEC 60603-7-41 (500 MHz unshielded)	IEC 60603-7-4 (250 MHz unshielded)
IEC 60603-7-51 (500 MHz shielded)	IEC 60603-7-5 (250 MHz shielded)
IEC 60512-25-9	
IEC 60512-27-100	

Attention: The test standard are not an automatic criteria for quality. They are only a description for test procedures. Re-embedded specify a very efficient and exact test procedure. Not for Cat 6_A only!

Coding for indoor optical fiber cable according VDE DIN 0888

Code		Description
J-		Indoor cable
	V	Tight buffer
	H	Loose buffer, unfilled
	W	Loose buffer, filled
	Y	PVC-cable jacket
	H	Jacket of halogen free material
	n	Fiber number
	E	Single-mode fiber
	G	Multi-mode fiber
	n	Core diameter (μm)
	n	Jacket diameter (μm)
	n	Damping coefficient (dB/km)
	B	Wavelength = 850 nm
	F	Wavelength = 1300 nm
	H	Wavelength = 1550 nm
	n	Bandwidth (MHz x km) resp. Dispersion (ps/(km x nm))













Example: outdoor cable
A-DQ(ZN)B2Y8G50/125B500

Coding for outdoor optical fiber cable according VDE DIN 0888

Code											Description
A-											Outdoor cable
	H										Loose buffer, unfilled
	W										Loose buffer, filled
	B										Bundle fiber, unfilled
	D										Bundle fiber, filled
		s									Metallic element in the cable soul
			F								Gel filling
			Q								Swelling flies
				2Y							PE-Jacket
				(L)2Y							Multi coated cable jacket
				(ZN)2Y							PE-Jacket with non-metallic strain relief
				(L) (ZN)2Y							Multi coated cable jacket with non-metallic strain relief
					B						cable armoring
					B2Y						cable armoring PE jacket
						n					Number of fibers per bundle
							E				Single-mode-fiber
							G				Multi-mode-fiber
								n			Core diameter (µm)
								n			Jacket diameter (µm)
								n			Damping coefficient (dB/km)
									B		Wavelength = 850 nm
									F		Wavelength = 1300 nm
									H		Wavelength = 1550 nm
										n	Bandwidth (MHz x km) resp. Dispersion (ps/(km x nm))
										LG	Stranding of layers

Optical fiber color code according IEC 60603

fiber no.	fiber color	fiber no.	fiber color
1	red	13	color with flange
2	green	14	color with flange
3	blue	15	color with flange
4	yellow	16	color with flange
5	white	17	color with flange
6	grey	18	color with flange
7	brown	19	color with flange
8	violet	20	color with flange
9	turquoise	21	color with flange
10	black	22	transparent with flange
11	orange	23	color with flange
12	pink	24	color with flange

Number of optical fiber or patch cord	FOTAG Code	Number of optical fiber or patch cord	FOTAG Code
1	Blue 	7	Red 
2	Orange 	8	Black 
3	Green 	9	Yellow 
4	Brown 	10	Purple 
5	Grey 	11	Pink 
6	White 	12	Turquoise 

Performance for Ethernet according IEEE 802.3 over optical fiber

application	standard	speed
10Base-FL	IEEE 802.3	10 Mbit/s
100Base-FX	IEEE 802.3u	100 Mbit/s
1000Base-SX 1000Base-LX	IEEE 802.3z	1 Gbit/s
10GBase-SR 10GBase-SR 10GBase-LX4 10GBase-LR 10GBase-LW 10GBase-ER 10GBase-EW	IEEE 802.3ae	10 Gbit/s

wavelength coding

wavelength	coding
L = 1310 nm	R = 64B/66B coding (10Gbit)
S = 850 nm	W = 64B/66B coding (10Gbit)
E = 1550 nm	X = 8B/10B coding (1Gbit)

New classification for optical fiber according EN 50173-1 (2002)

Class	Fiber
OM1	G 62,5/125µm
OM2	G 50/125µm
OM3	G 50/125µm
OM4 (pending)	G 50/125µm
OS1	E 09/125µm

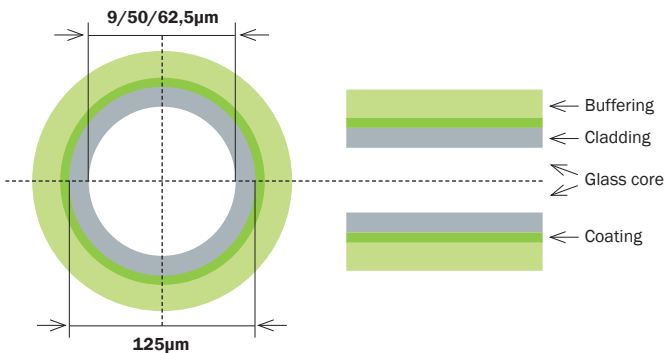

New classification for optical fiber link according EN 50173-1 (2002)

Channel	Maximal channel attenuation (dB)			
	Multimode		Singlemode	
	850nm	1300nm	1310nm	1550nm
OF 300	2,55	1,95	1,80	1,80
OF 500	3,25	2,25	2,00	2,00
OF 2000	8,50	4,50	3,50	3,50
OF 300 \triangleq optical fiber link distance 300 meters				

	OM 1 (62,5/125 μ m)	OM 2 (50/125 μ m)	OM 3 (50/125 μ m)	OM 4 (50/125 μ m)	OS 1 (9/125 μ m)	OS 2 (9/125 μ m)
10Base-F	2.000m	2.000m	2.000m	2.000m	n./a.	n./a.
100Base-FX	2.000m	2.000m	2.000m	2.000m	n./a.	n./a.
1000Base-SX	275m	550m	900m	1.100m	n./a.	n./a.
1000Base-LX	550m	550m	550m	550m	2.000m	5.000m
10GBase-SR	35m	82m	300m	550m	n./a.	n./a.
10GBase-LR	n./a.	n./a.	n./a.	n./a.	2.000m	10.000m

Optical transfer windows

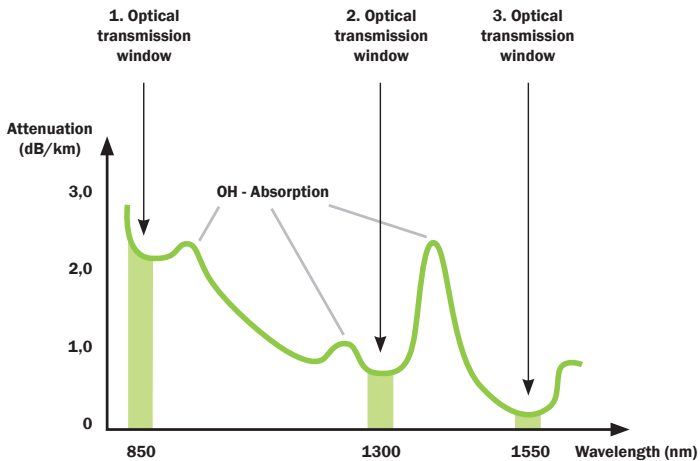

Optical transfer windows

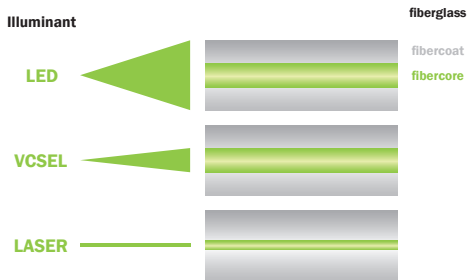

Source	Fiber	Wavelength	Typical application
LED	G 62,5/125 μ m G 50/125 μ m	850nm	up to 100Mbit/s
VCSEL	G 50/125 μ m	850nm or 1310nm	up to 10Gbit/s
LASER	E 09/125 μ m	1310nm or 1550nm	typical above 10Gbit/s

VCSEL - Vertical Cavity Surface Emitting

ST connector



- IEC 61754-2
- Bayonet lock
- Ceramic ferule Ø 2,5mm
- One piece design
- Norm IEC 61754-2
- Model: SM & MM
- Polish: PC & APC
(depend on application)

SC connector



- IEC 61754-4
- Push pull lock
- Ceramic ferule Ø 2,5mm
- Duplex clip for the connection of two plugs
- Norm IEC 61754-4
- Model: SM & MM
- Polish: PC & APC
(depend on application)

LC connector



- IEC 61754-20
- Latched Push pull lock
- Ceramic ferule Ø 1,25mm
- Duplex clip for the connection of two plugs
- High packing density
- Norm IEC 61754-20
- Model: SM & MM
- Polish: PC & APC
(depend on application)

SC Pre-Polished Fiber Optic connector



- Zirconia ceramic ferrule
- Diameter tight buffer: 900µm
- Diameter cable jacket: 2,0m / 3,0mm and 250µm on request
- Insertion loss: ~ 0,1db
- Return loss: ~ ≥ 50db

Mechanical splice



- Insertion loss: ~ 0,1db
- Return loss: ~ ≥ 50db
- Operating temperature: -40°C ~ +70°C
- Tension force tight buffer: 4,9N (900µm)
- Material connector body: Polycarbonat, clear
- Filling: Index matching gel

E2000 connector



- IEC 61754-15
- Latched Push pull lock
- Ceramic ferrule Ø 2,5mm
- Integrated protection cover
- Encoding: color & mechanically
- Norm IEC 61754-15



UPC Δ physical contact

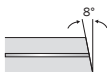





APC Δ Angled PC

Color	Fiber	Polish
Beige/bl/beige	MM, 50µm	UPC
Beige/b/b	MM, 62,5µm	UPC
Blue/bl/bl	SM, 9µm	UPC
Green/gr/gr	SM, 9µm	APC 8°

IP enclosure type

1st code number

1st code number	Protection against foreign bodies entering	Symbol
0	Not protected	
1	Protected against foreign bodies Ø 50 mm and bigger Protection against touching dangerous parts with the back of the hand	
2	Protected against foreign bodies Ø 12.5 mm and 80mm long The structured test item must be a sufficient distance from dangerous parts	
3	Protected against foreign bodies Ø 2.5 mm and bigger Protection against touching dangerous parts with a tool (The touch probe of 2.5mm diameter must not be able to enter)	
4	Protected against foreign bodies Ø 1.0 mm and bigger (The touch probe of 1.0 mm diameter must not be able to enter)	
5	Dust-protected Protection against touching dangerous parts with a wire (The touch probe of 1.0 mm diameter must not be able to enter)	
6	Dust-proof Protection against touching dangerous parts with a wire (The touch probe of 1.0 mm diameter must not be able to enter)	





Example IP 44:

1st code number = 4 (protection against foreign bodies bigger than 1 mm Ø)

2st code number = 4 (protection against splash water from all directions)

IP enclosure type

2st code number

1st code number	Protection against water entering with damaging effects	Symbol
0	Not protected	
1	Protected against dripping water Definition: Drops falling vertically must not have any damaging effects	
2	Protected against dripping water up to 60° to the vertical Definition: Drops falling vertically must not have any damaging effects if the housing is angled up to 15° on both sides of the vertical	
3	Protected against spray water up to 60° to the vertical Definition: Water that is sprayed at an angle of up to 60° on both sides of the vertical must not have any damaging effects	
4	Protected against splash water from all directions Definition: Water that splashes against the housing from all directions must not have any damaging effects	
5	Protected against jet water from all directions Definition: Water that is directed as a jet against the housing from all directions must not have any damaging effects	
6	Protected against strong jet water Definition: Water that is directed as a strong jet against the housing from all directions must not have any damaging effects	
7	Protected against the effects when submerged temporarily under specified pressure and time conditions Definition: Water must not enter in an amount which causes damaging effects if the housing is temporarily submerged in water under standardised pressure and time conditions	
8	Protected against the effects when submerged long-term under specified pressure for a defined period of time Definition: Water must not enter in an amount which causes damaging effects if the housing is submerged long-term under water, under conditions which must be agreed on between manufacturer and user. The conditions must, however, be more difficult than those for code number 7.	

sales@digitus-professional.com
0800-DIGITUS
0800-3444887

www.digitus-professional.com

DM-30029



44,45mm \cong 1 $\frac{3}{4}$ inch

1 RU

2 RU

1

2

3

4

5

6

7

8

9

10